

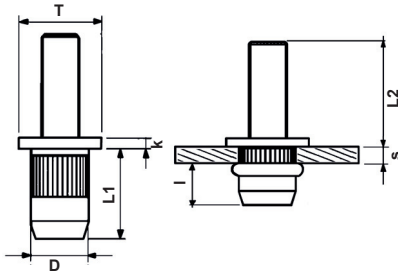



STEEL ZINC PLATED Cr III
 STAHL VERZINKT Cr III
 ACIER ZINGUÉ Cr III
 ACERO CINCADO Cr III

BLIND RIVET BOLTS
 BLINDNIETSCHRAUBEN
 GOUJONS À SERTIR
 INSERTO MACHO

ITTM

FLAT HEAD
 FLACHKOPF
 TÊTE CYLINDRIQUE
 CABEZA PLANA





CODICE CODE		S GRIP	D +/-0,1	 +0,1/-0	T +/-0,3	K +/-0,2	L1	L2 MIN	I ~	 Nm
85ACITTM0515C 85ACITTM0525C	M5	0,5 - 2,5	6,9	7	10	1	13,5	15 25	9-10	7
85ACITTM0615C 85ACITTM0625C	M6	0,5 - 3	8,9	9	12,3	1,4	15,7	15 25	10-11	10
85ACITTM0820C 85ACITTM0825C	M8	1,0 - 3,5	10,9	11	14,5	1,5	18,5	20 25	12-13	25

ITTM

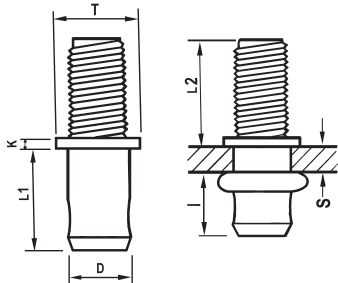
FLAT HEAD
 FLACHKOPF
 TÊTE CYLINDRIQUE
 CABEZA PLANA





CODICE CODE		S GRIP	D +0,07/-0,1	 +0,1/-0	T +/-0,3	K +/-0,15	L1	L2 MIN	I ~	 Nm
85ACITTM0410C 85ACITTM0410L 85ACITTM0415C 85ACITTM0415L	M4	0,5 - 2,0 2,0 - 3,0 0,5 - 2,0 2,0 - 3,0	5,4	5,5	8	0,8	8	10 10 15 15	3,5 4 3,5 4	5
85ACITTM0515C 85ACITTM0525C	M5	0,5 - 2,5	6,9	7	10	1	12	15 25	8	7
85ACITTM0615C 85ACITTM0625C	M6	0,5 - 3,0	8,9	9	13	1,5	14,5	15 25	9	10
85ACITTM0820C 85ACITTM0825C	M8	0,5 - 3,0	10,9	11	16	1,5	15,5	20 25	9,5	25

ITSEM

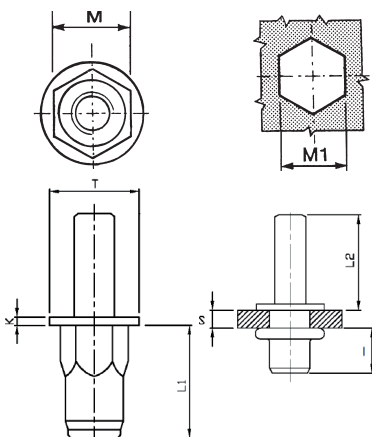
FLAT HEAD
 FLACHKOPF
 TÊTE CYLINDRIQUE
 CABEZA PLANA



CODICE CODE		S GRIP	M +0,07/-0,1	M1 +0,1/-0	T +/-0,3	K +/-0,15	L1	L2 MIN	I ~	 Nm
85ACITSEM0515C 85ACITSEM0525C	M5	0,5 - 2,5	6,9	7	10	1	13,5	15 25	10	7
85ACITSEM0615C 85ACITSEM0625C	M6	0,5 - 3,0	8,9	9	12,7	1,35	16	15 25	11,5	10
85ACITSEM0820C 85ACITSEM0825C	M8	1,0 - 3,5	10,9	11	16	1,5	18,5	20 25	13,5	25